

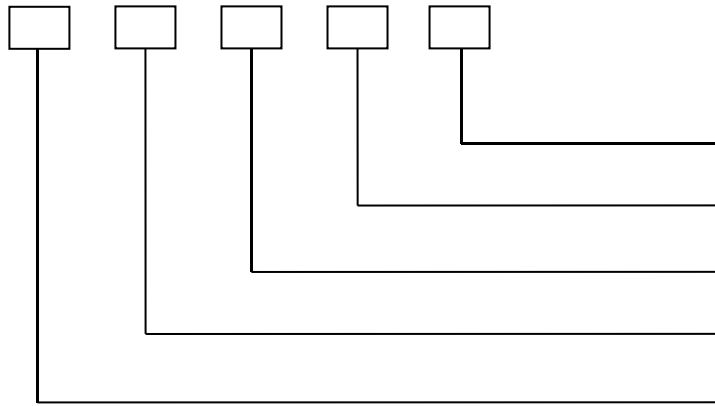

森霸传感科技股份有限公司



1.

2 (T=25° C, Vdd=3V)

REL					
REL					
REL					

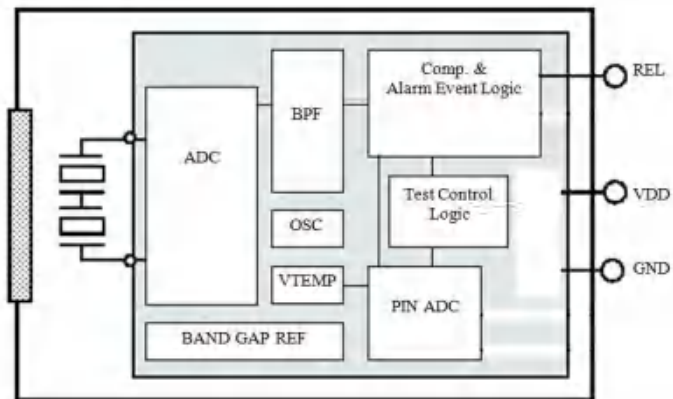

3.

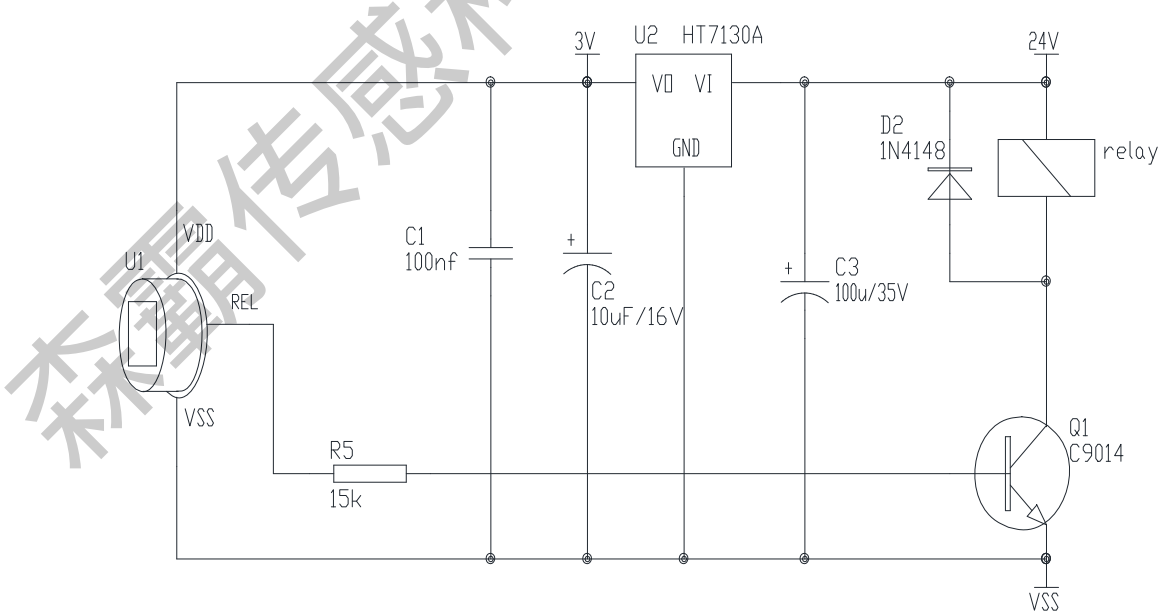
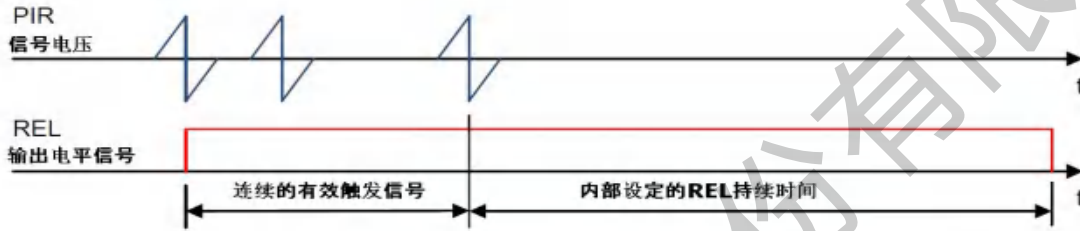

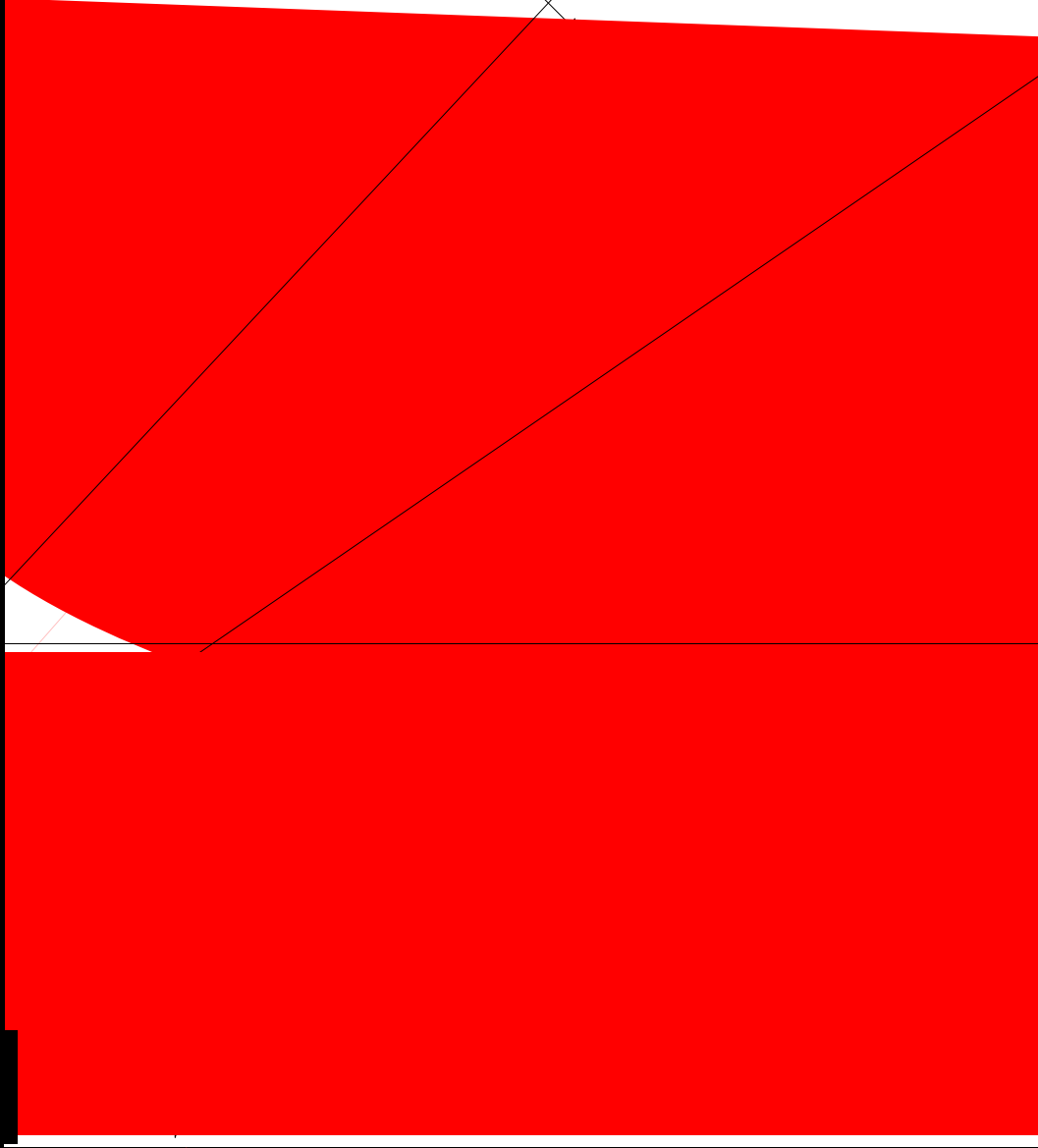
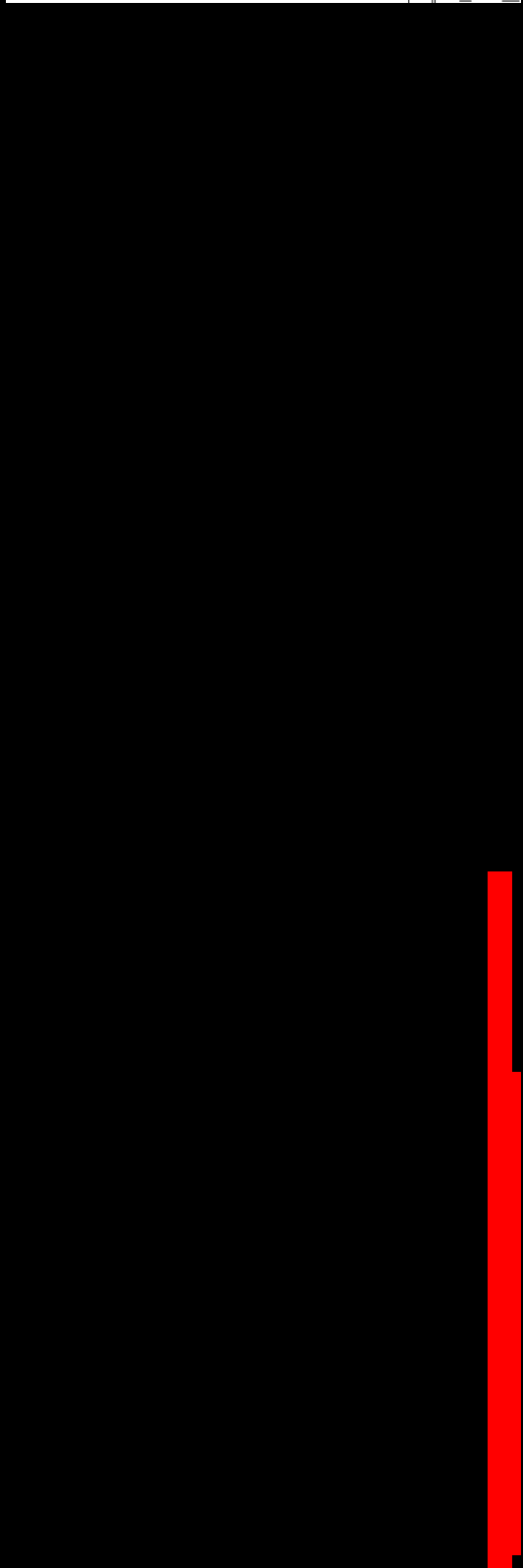
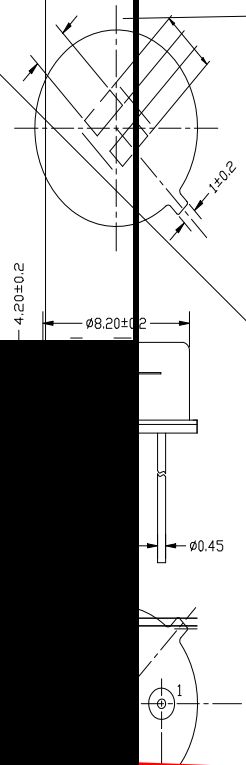
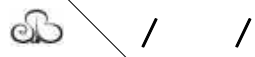



1. PI R

2. PI R

PCB

PI R

3. PI R VDD

100NF

PI R VDD

1.

1

350

3

2.

1

260± 5

1500± 300mm / mi n

2

260

3S,

3

PI R

PCB

1mm

PI R

PCB

4

PI R

1. PI R

PI R

1

PI R

1

2

3

2

PI R

1

2

2.

1

2

HDPE

3

4

5

6

7

